

Fact sheet **ECO-Skate** iN80L-CR

Load moving system, steerable, 3-load points

HTS

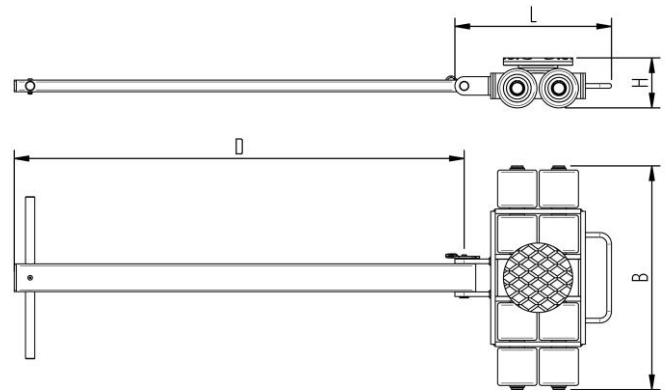

Specification:

Heavy-duty load moving system for the professional indoor heavy load transport on clean, smooth and level floors, incl. pulling bar with handle or pulling eye, turntable with anti slip rubber pad and high-quality HTS nylon wheels, which are abrasion-resistant and non-marking and suitable for all smooth industrial smooth and level floors. In combination with a S, DUO or two ROTO skates with the same installation height, it forms a secure overall system with 3 pickup points.

Technical data of load moving system:

# 12 080 01 10	Ø 150 mm	6,0 x 80 = 480 mm ² ▼ 20,8 MPa
MAT NY, 80 Shore D	L x B x H 339 x 483 x 110 mm	38,4 cm ²
8000 daN	D = 1000 mm	200 daN*
# 8	21 kg	160 daN*

Equipped with the following wheel:

# 11 085 10 14	6,0 x 80 = 480 mm ² ▼ 20,8 MPa
MAT NY, 80 Shore D	1000 daN
Ø85x87 - Ø25 mm	V _{max} = 2 km/h



Please always observe the operating instructions, their safety instructions and local conditions!

# Part No.	# Number of wheels	Ø Load Area in mm	Area mm ² of the roller surface pressure ▼ N / mm ²	→ Traction* in daN, required force to move the load at a steady speed of 2 km/h under ideal conditions
MAT Wheel material layer, core: AL Aluminium, NY Nylon PU Polyurethane, ST Steel	Dimensions of wheel, inside ball bearing diameter mm	Dimensions in mm L x B x H	Loaded area per skate in cm ²	
Carrying Capacity of load moving skate in daN at 2km/h max.	Weight kg	Steering bar length D for L, adjustability V for S and DUO skate systems	Starting resistance* in daN, required force to start moving, under ideal conditions	* Varies depending on the tolerances of the floor and ambient situation. All information without guarantee.