

# Fact sheet **ECO-Skate** i30L

Load moving system, steerable, 3-load points

# HTS

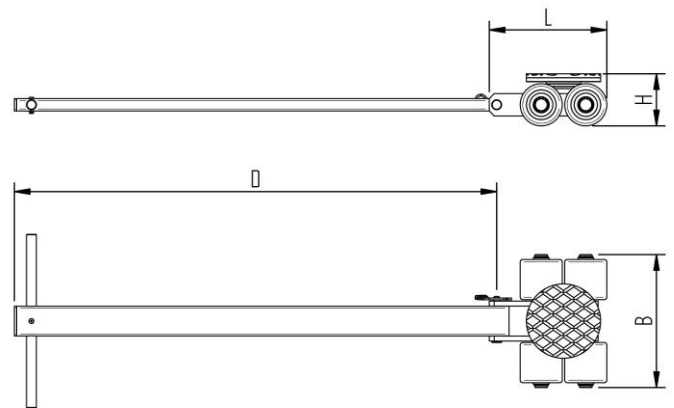

## Specification:

Heavy-duty load moving system for the professional indoor heavy load transport on clean, smooth and level floors, incl. pulling bar with grab handle or pulling eye, turntable with anti-slip rubber pad and high-quality 3-component polyurethane wheels, which are abrasion-resistant, cut-resistant and non-marking and suitable for all smooth and level floors with slight unevenness. In combination with an S, DUO or two ROTO skates with the same installation height it forms a safe overall system with 3 load points.

## Technical data of load moving system:

# 10 030 00 10	Ø 150 mm	$11,3 \times 78 = 879 \text{ mm}^2$ ▼ 8,4 MPa
MAT PU, ST, 93 Shore A	L x B x H 238 x 268 x 110 mm	35,2 cm <sup>2</sup>
3000 daN	D = 1000 mm	150 daN*
# 4	14 kg	90 daN*

## Equipped with the following wheel:

# 11 085 00 14	$11,3 \times 78 = 879 \text{ mm}^2$ ▼ 8,4 MPa
MAT PU, ST, 93 Shore A	750 daN
Ø85x87 - Ø25 mm	V <sub>max</sub> = 2 km/h



**Please always observe the operating instructions, their safety instructions and local conditions!**

# Part No.	# Number of wheels	Ø Load Area in mm	Area mm <sup>2</sup> of the roller surface pressure ▼ N / mm <sup>2</sup>	→ Traction* in daN, required force to move the load at a steady speed of 2 km/h under ideal conditions
MAT Wheel material layer, core: AL Aluminium, NY Nylon PU Polyurethane, ST Steel	Dimensions of wheel, inside ball bearing diameter mm	Dimensions in mm L x B x H	Loaded area per skate in cm <sup>2</sup>	
Carrying Capacity of load moving skate in daN at 2km/h max.	Weight kg	Steering bar length D for L, adjustability V for S and DUO skate systems	Starting resistance* in daN, required force to start moving, under ideal conditions	* Varies depending on the tolerances of the floor and ambient situation. All information without guarantee.